

Chemistry

Laboratory Equipment

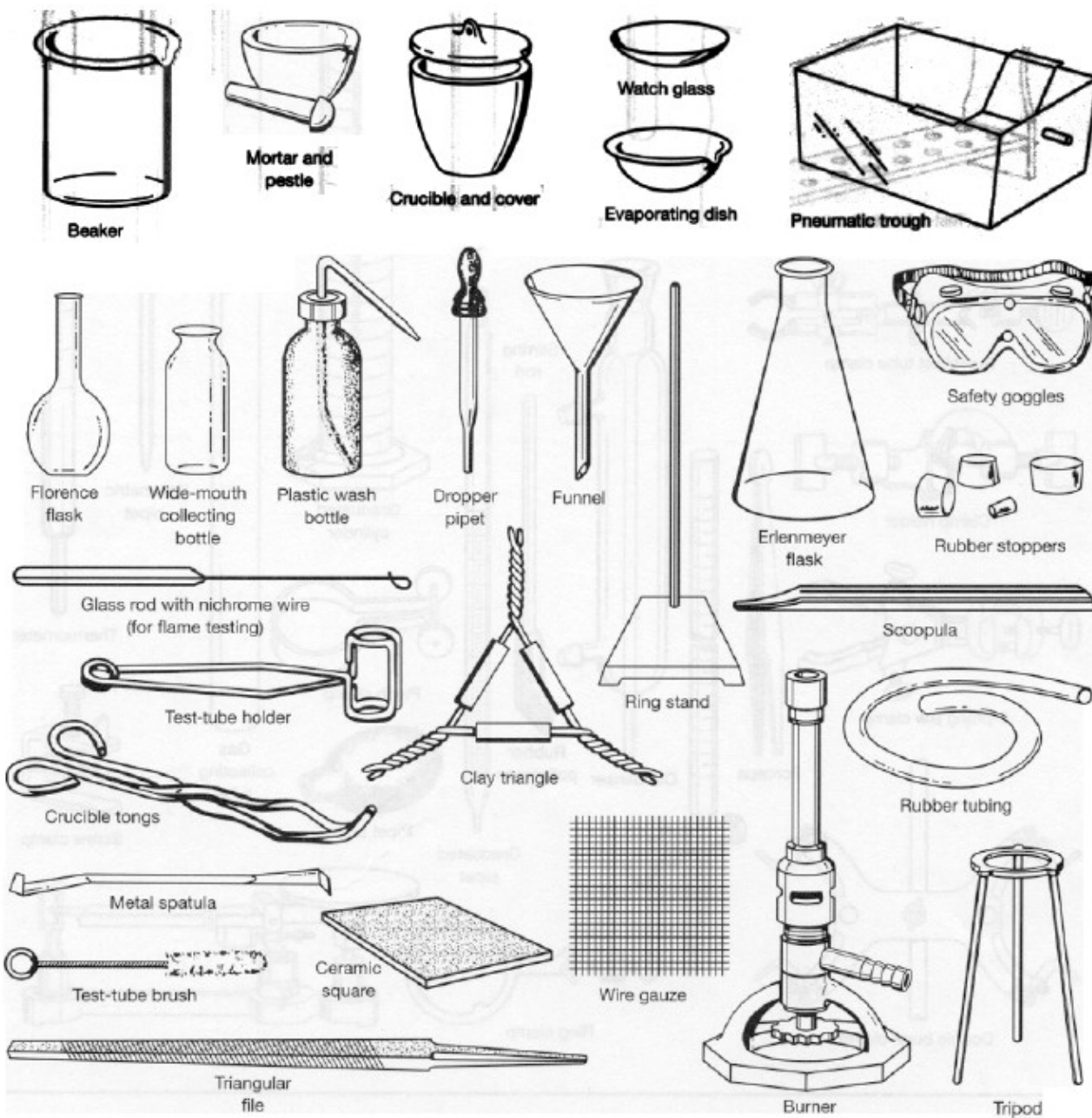

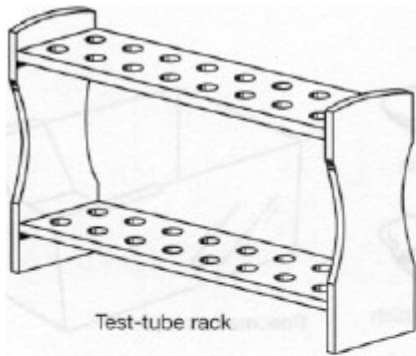

Test-tube rack

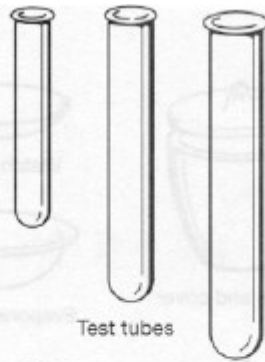

Test tubes

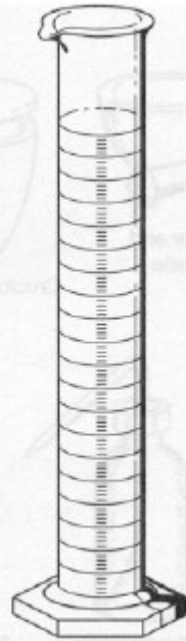

Graduated cylinder



Gas collecting tube



Volumetric pipet



Thermometer

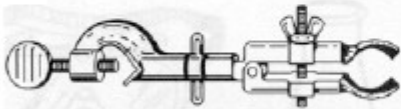

Buret/test tube clamp



Clamp holder

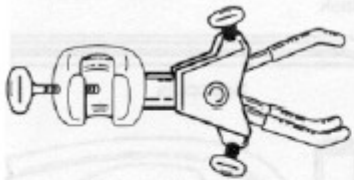

3-prong jaw clamp



Forceps



Buret

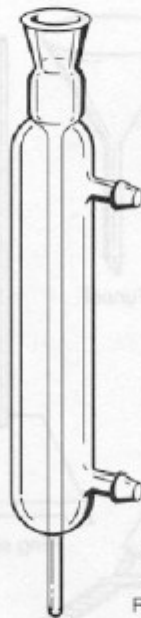

Condenser



Stirring rod

Rubber policeman

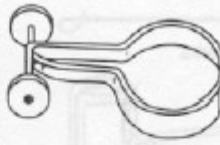

Pinch clamp



Pipet bulb



Graduated pipet

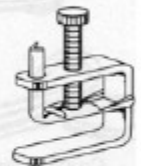

Screw clamp

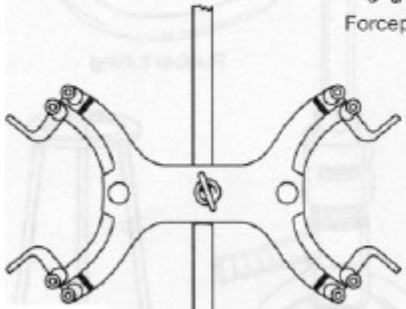

Double buret clamp



Ring clamp

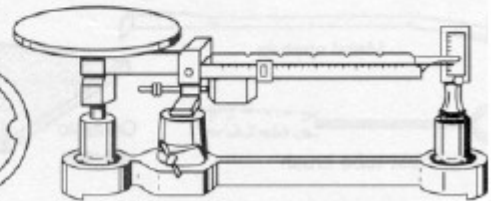

Platform balance (triple beam)